

# Catalogue For Operation Room



THE WORLD OF SURGICAL INSTRUMENTS



1:2

**Standard**

1:1

AA 100-11	AA 100-13	AA 100-14	AA 100-16	AA 100-18	AA 100-20
11,5 cm / 4½"	13 cm / 5"	14,5 cm / 5¾"	16,5 cm / 6½"	18,5 cm / 7"	20 cm / 8"

1:1

AA 101-11	AA 101-13	AA 101-14	AA 101-16	AA 101-18	AA 101-20
11,5 cm / 4½"	13 cm / 5"	14,5 cm / 5¾"	16,5 cm / 6½"	18,5 cm / 7"	20 cm / 8"

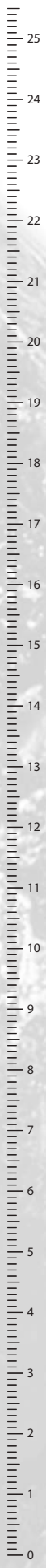



**Standard**

1:1



AA 102-11  
11,5 cm / 4½"

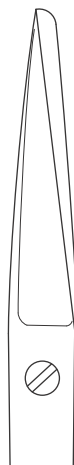

AA 102-13  
13 cm / 5"



AA 102-14  
14,5 cm / 5¾"



AA 102-16  
16,5 cm / 6½"



AA 102-18  
18,5 cm / 7"



AA 102-20  
20 cm / 8"

1:1



AA 103-11  
11,5 cm / 4½"



AA 103-13  
13 cm / 5"



AA 103-14  
14,5 cm / 5¾"



AA 103-16  
16,5 cm / 6½"



AA 103-18  
18,5 cm / 7"



AA 103-20  
20 cm / 8"



**Standard**

1:1

AA 104-11	AA 104-13	AA 104-14	AA 104-16	AA 104-18	AA 104-20
11,5 cm / 4½"	13 cm / 5"	14,5 cm / 5¾"	16,5 cm / 6½"	18,5 cm / 7"	20 cm / 8"

1:2

1:1

AA 105-11	AA 105-13	AA 105-14	AA 105-16	AA 105-18	AA 105-20
11,5 cm / 4½"	13 cm / 5"	14,5 cm / 5¾"	16,5 cm / 6½"	18,5 cm / 7"	20 cm / 8"

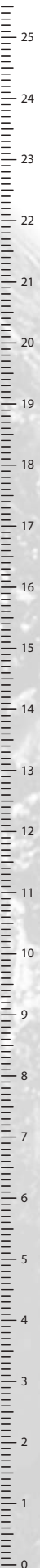



**Iris**

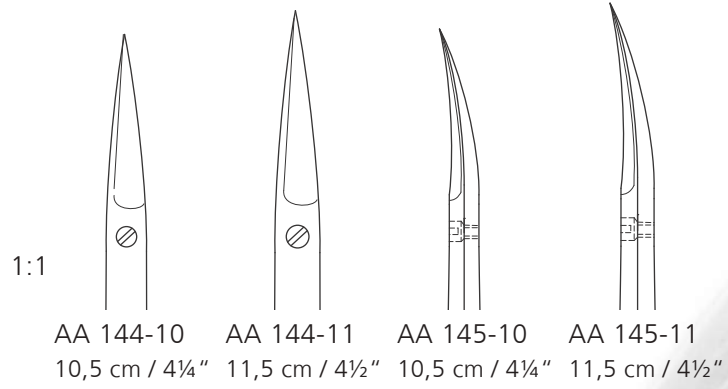

**Joseph**

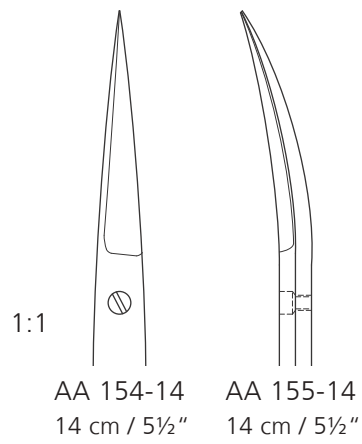



**Mayo**

1:1

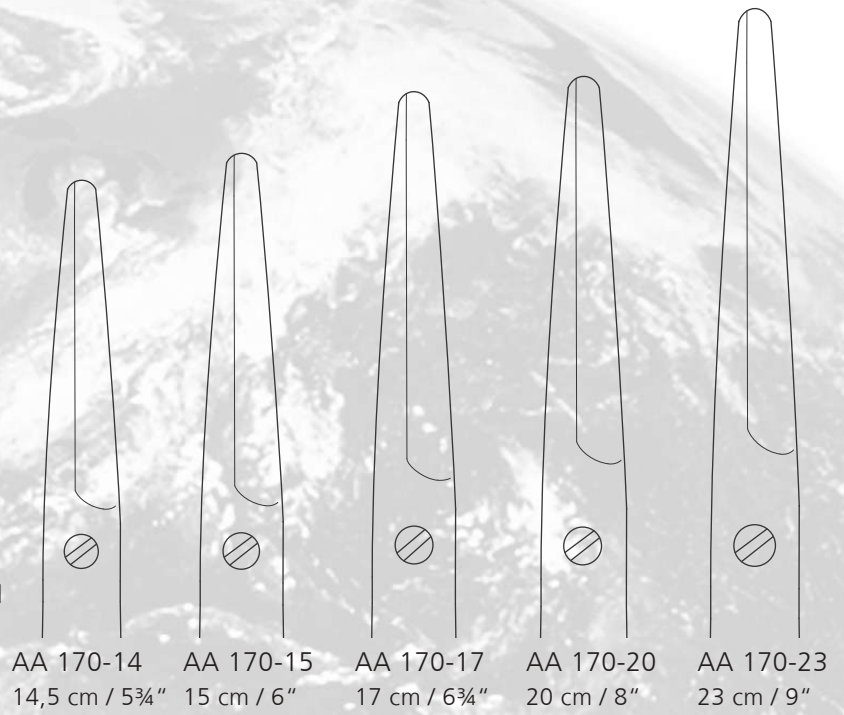

1:1

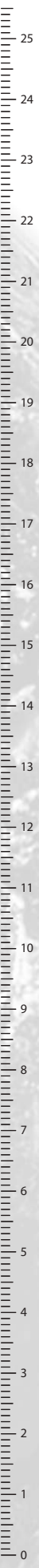
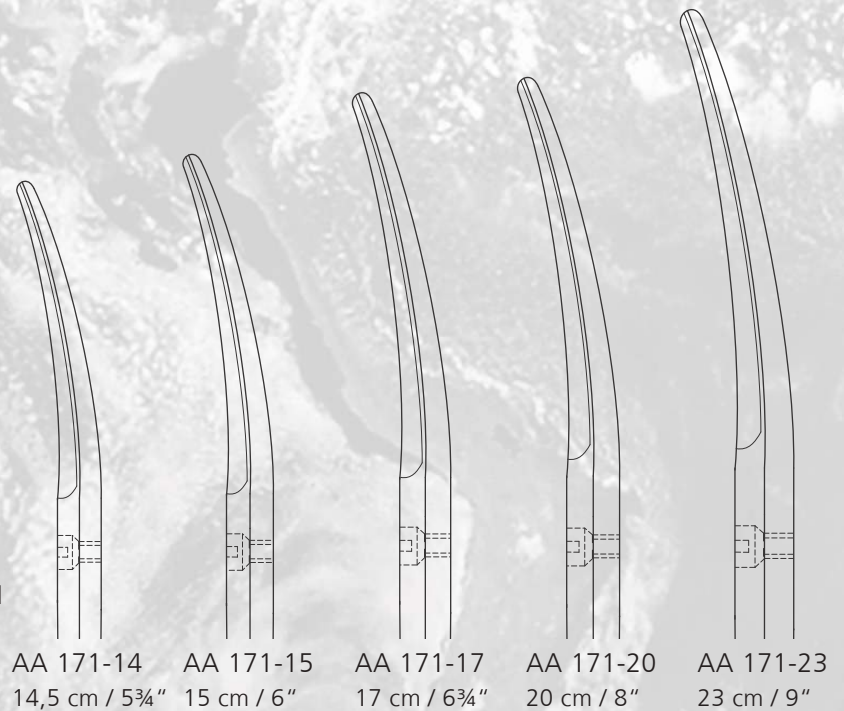



1:2

**Mayo-Style**

1:1

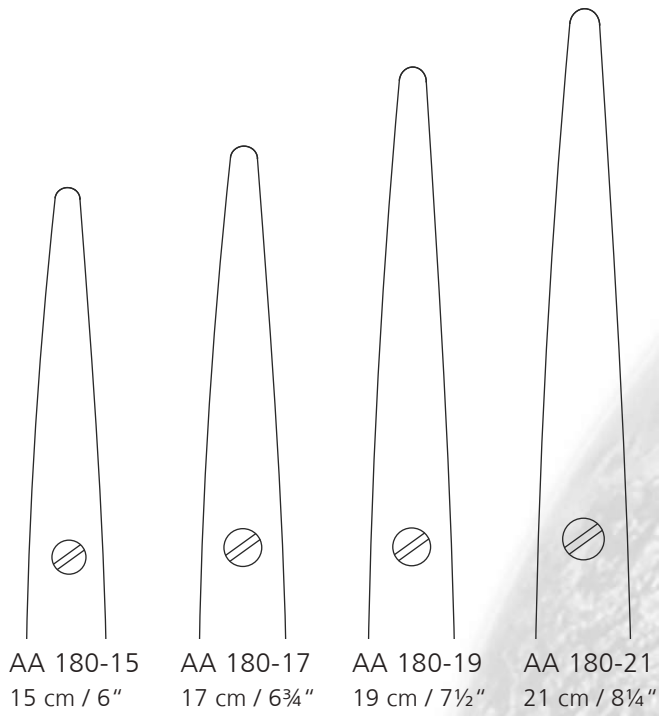

1:1

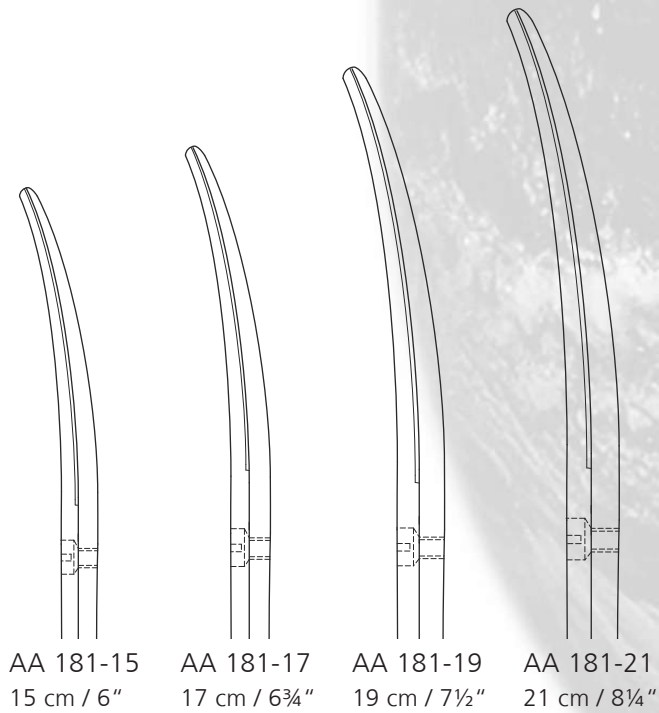

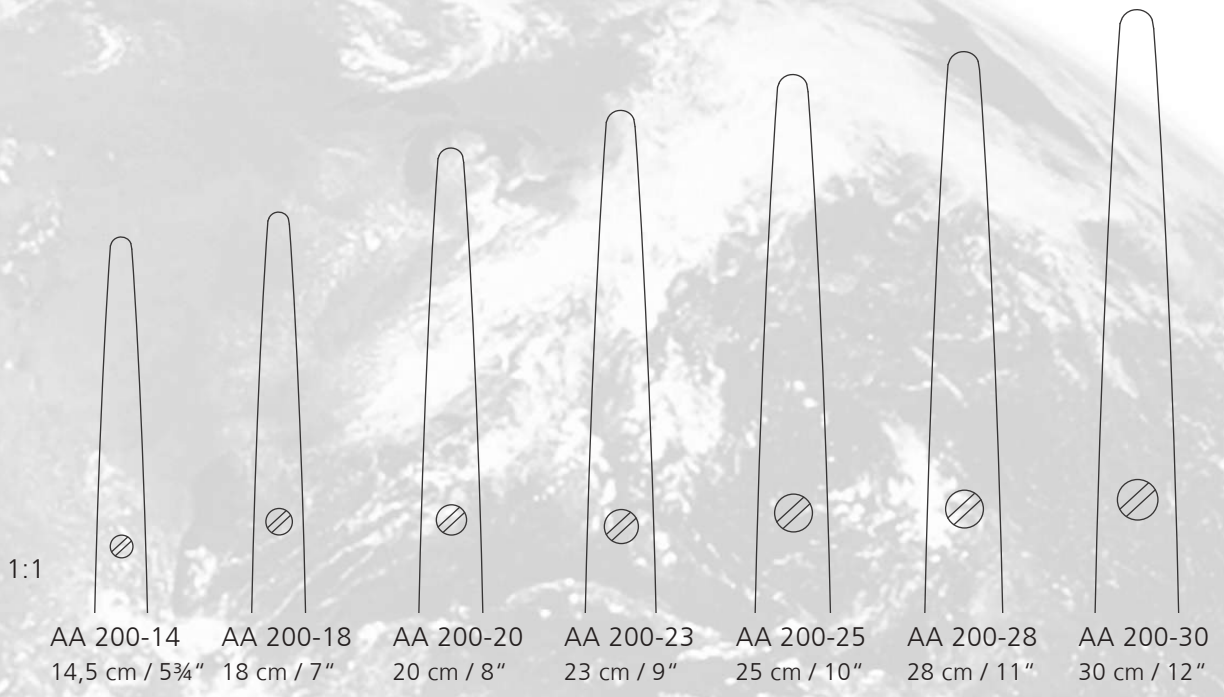

**Metzenbaum**

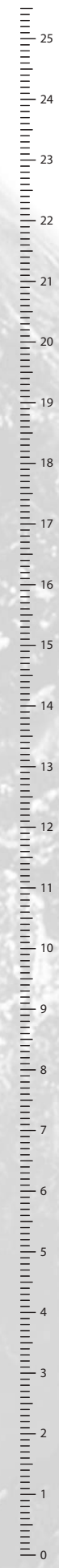
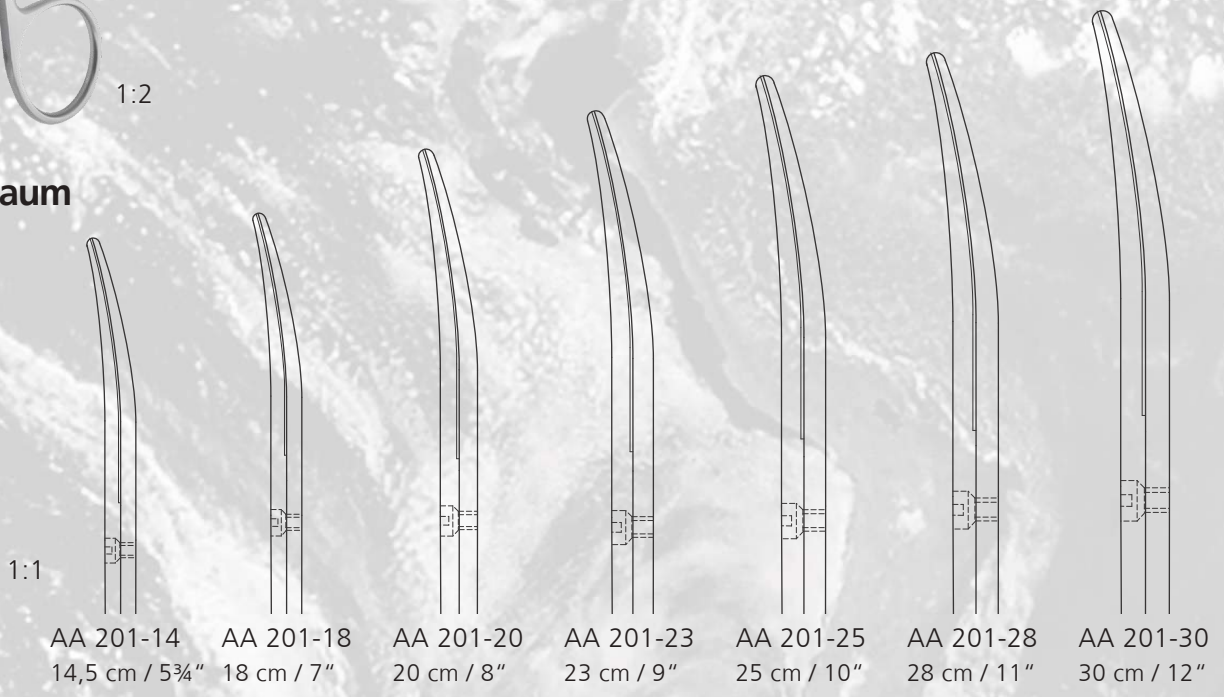



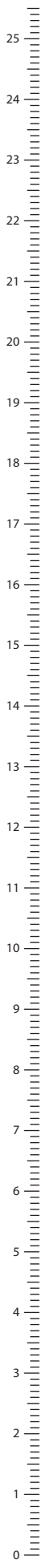

**Metzenbaum**

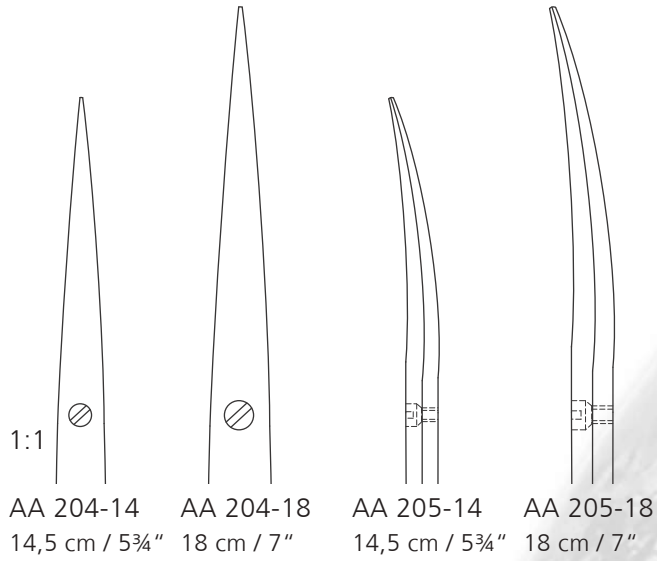

**Metzenbaum**

fein  
fine  
delgado

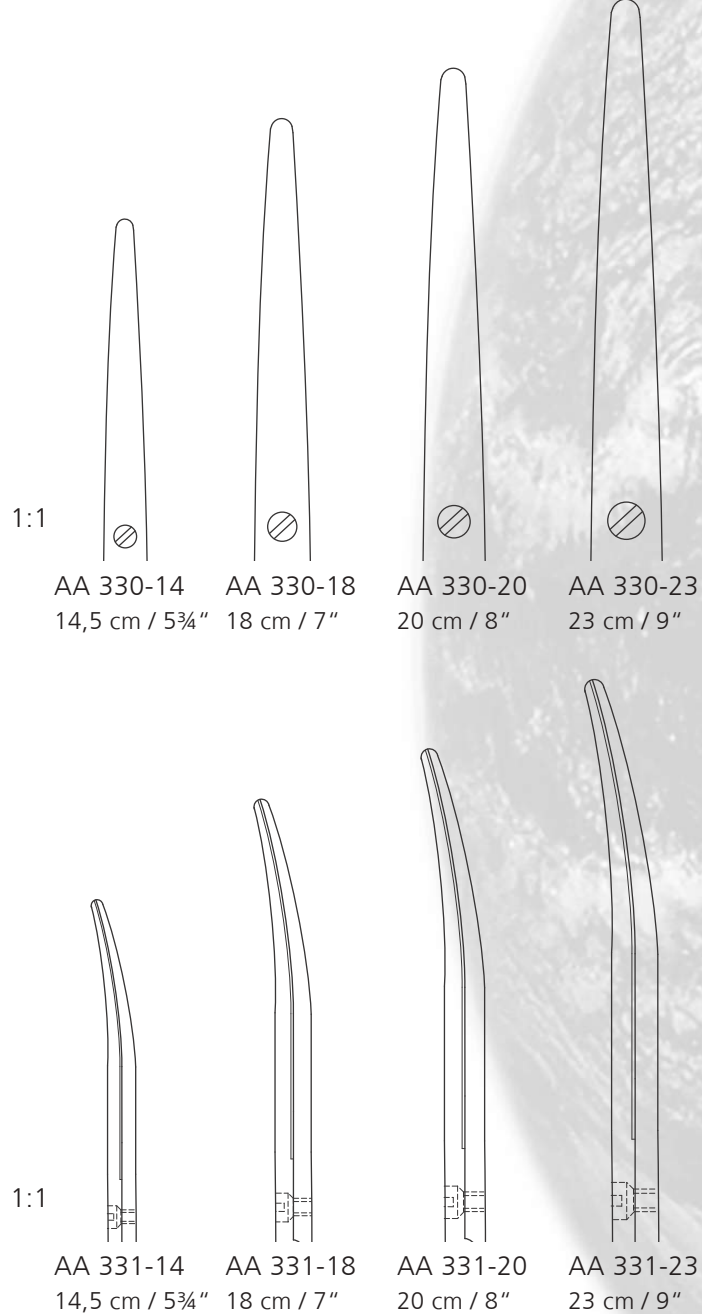



1:2

**Baby-Metzenbaum**

1:1



AA 400-11  
 11,5 cm / 4½"



AA 401-11  
 11,5 cm / 4½"



1:2

**Kilner (Ragnell)**

1:1



AA 410-13  
 13,5 cm / 5"



AA 411-12  
 12 cm / 4¾"



AA 411-15  
 15 cm / 6"

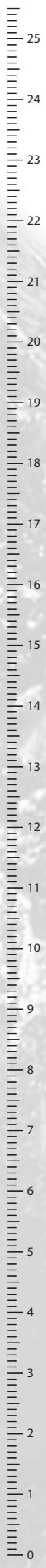

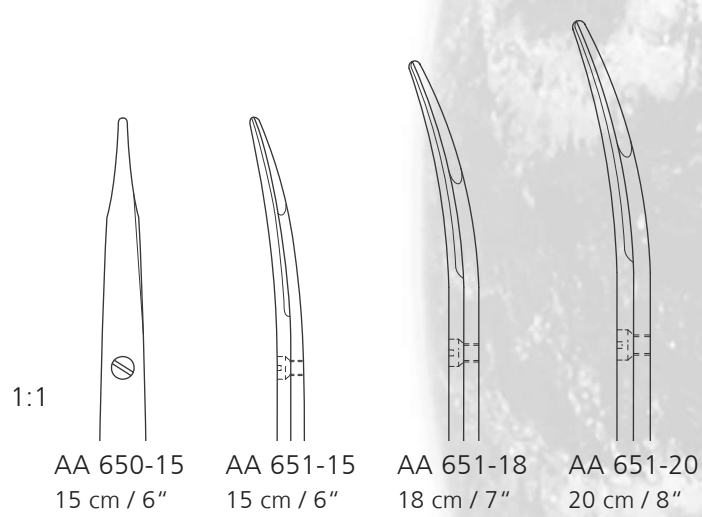
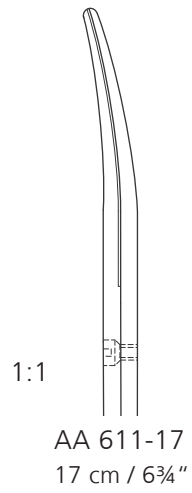



**Lister**

1:2

1:1



AB 907-09  
 9 cm / 3½"



AB 907-11  
 11 cm / 4¼"



AB 907-14  
 14 cm / 5½"



AB 907-18  
 18 cm / 7"

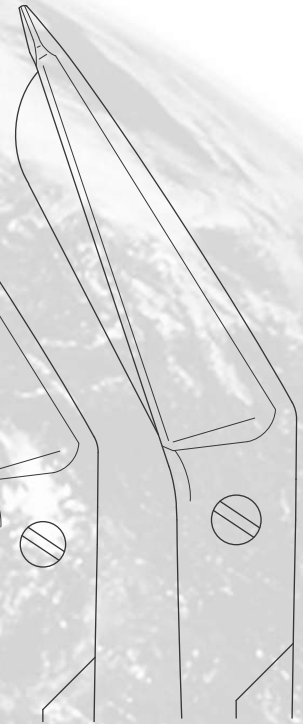

AB 907-20  
 20 cm / 8"

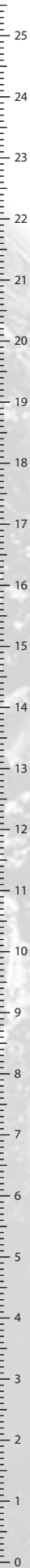

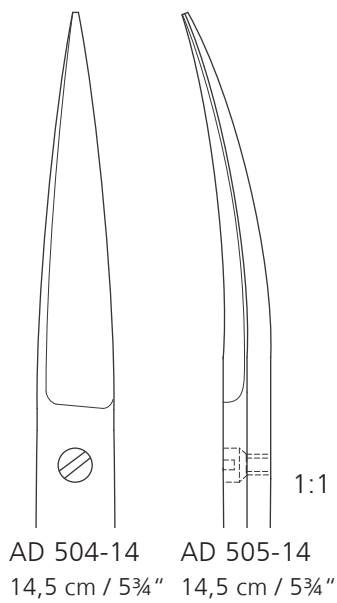
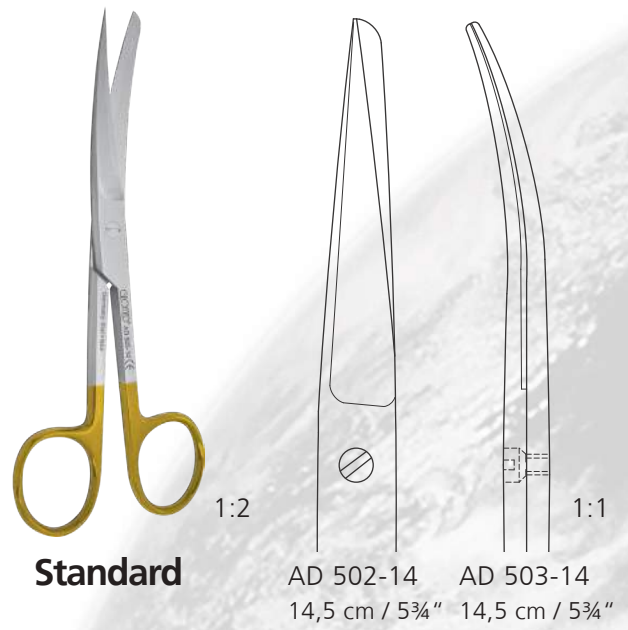
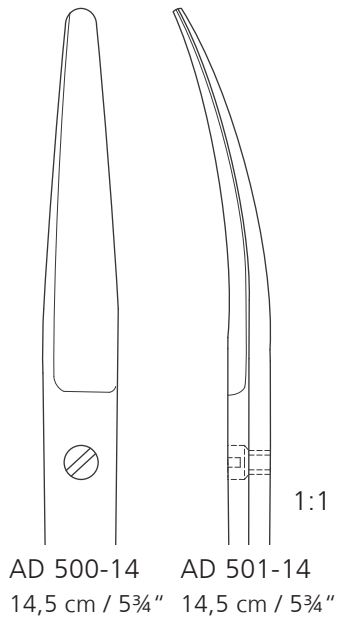



**Mayo**

1:2

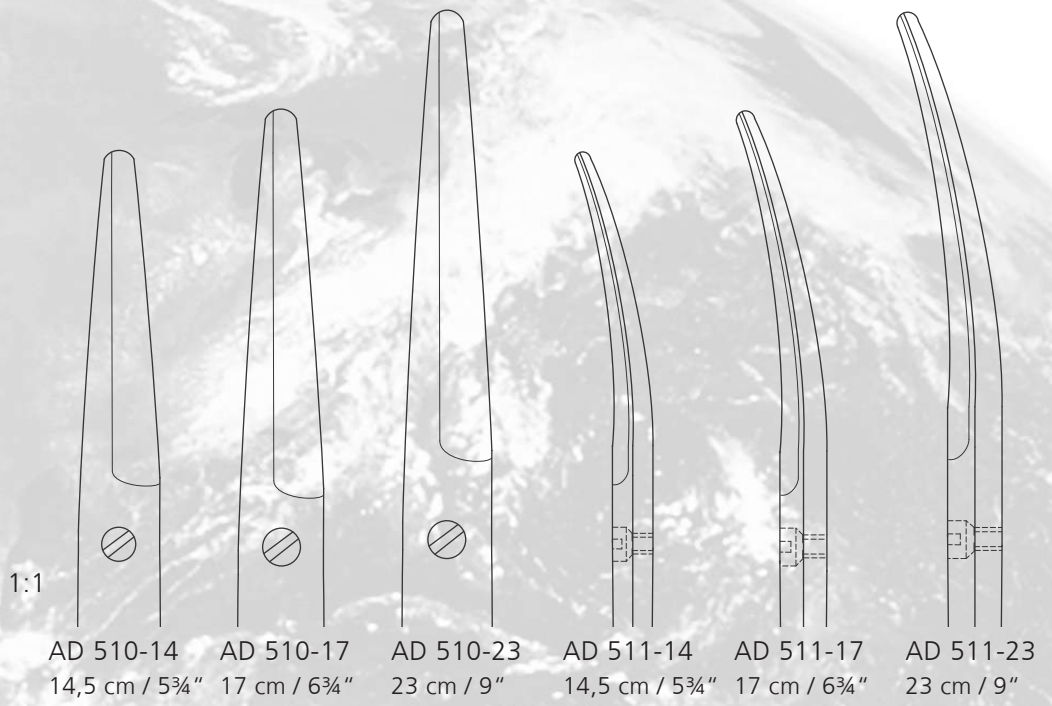

AD 518-17  
17 cm / 6¾"



AD 519-17  
17 cm / 6¾"



**Lexer**

1:2

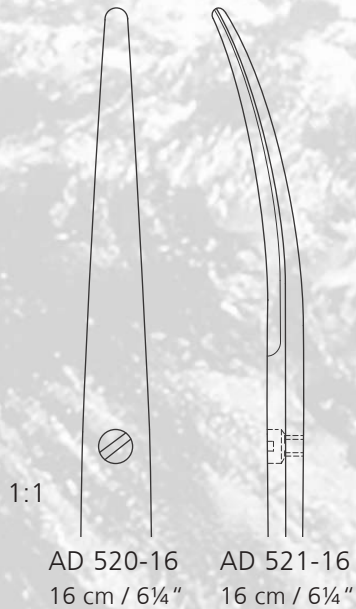

AD 529-16  
16 cm / 6¼"

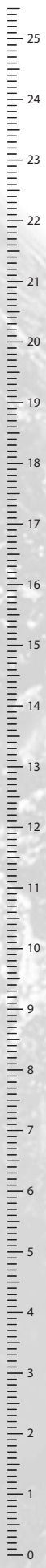



1:2

**Mayo-Style**

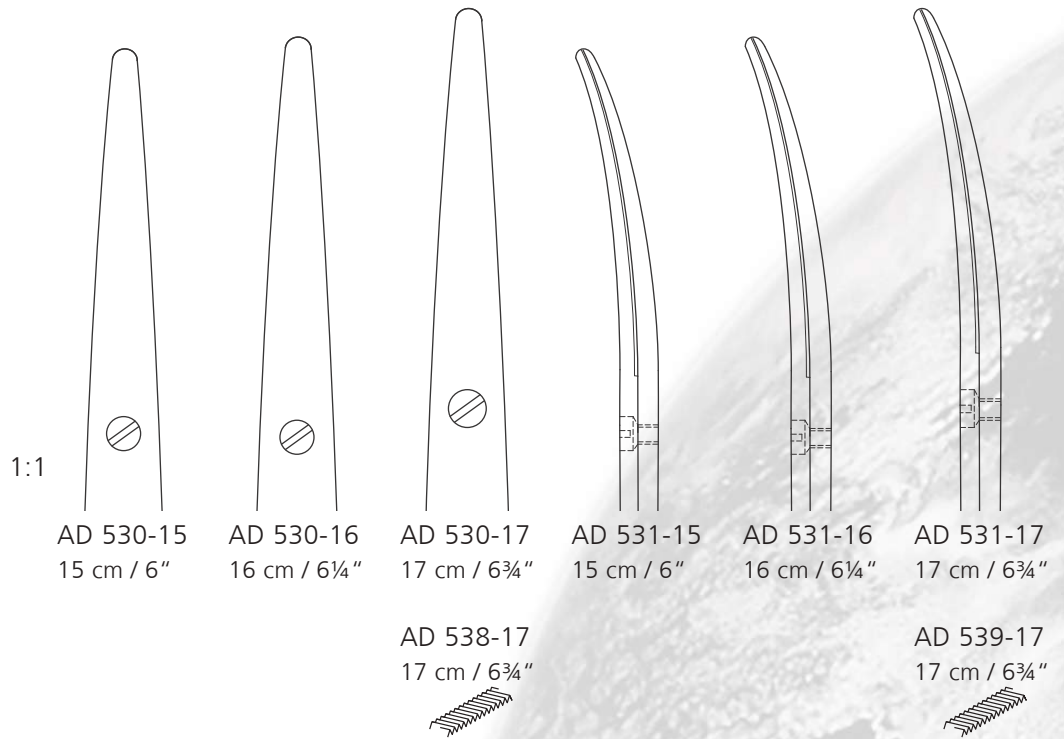

1:2

**Metzenbaum**

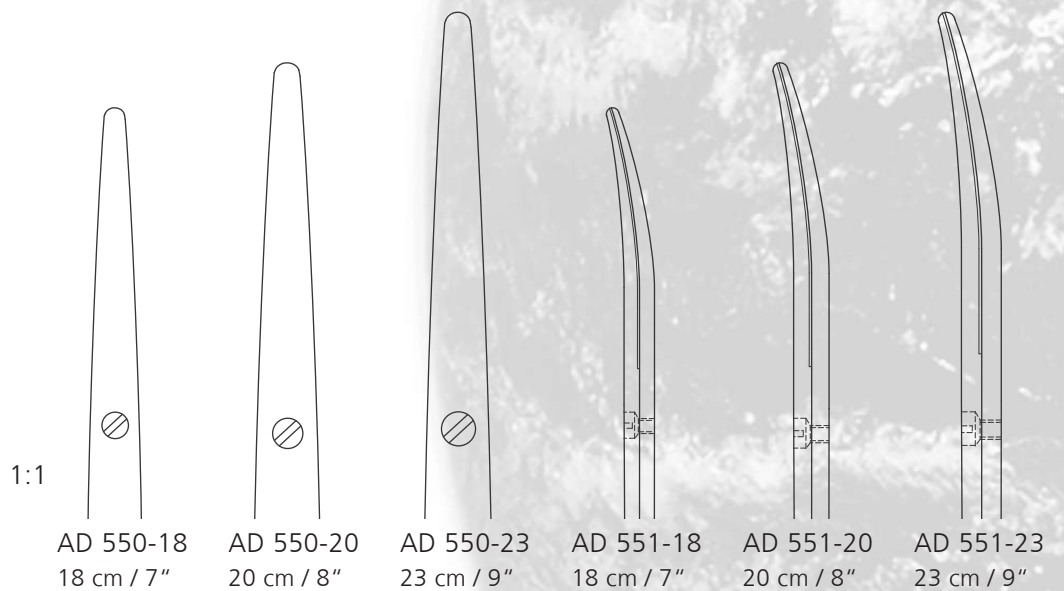



**Metzenbaum**

fein  
fine  
delgado

1:1



AD 560-14  
14,5 cm / 5¾"



AD 560-18  
18 cm / 7"



AD 560-20  
20 cm / 8"



AD 560-23  
23 cm / 9"

1:1



AD 561-14  
14,5 cm / 5¾"



AD 561-18  
18 cm / 7"



AD 561-20  
20 cm / 8"



AD 561-23  
23 cm / 9"

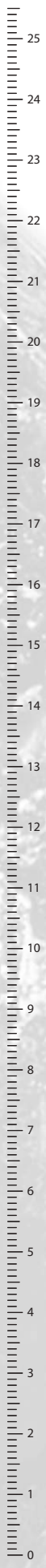





1:2

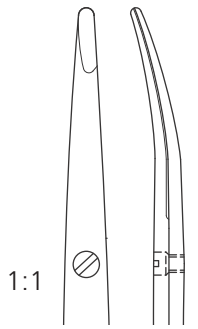

1:1

AD 629-12  
12,5 cm / 5"

**Ragnell**



1:2

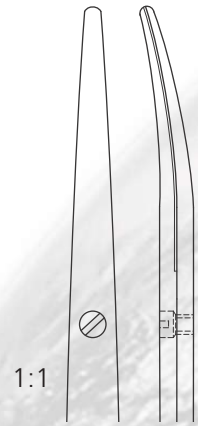

1:1

AD 651-17  
17 cm / 6¾"

**Toennis-Adson**



1:2

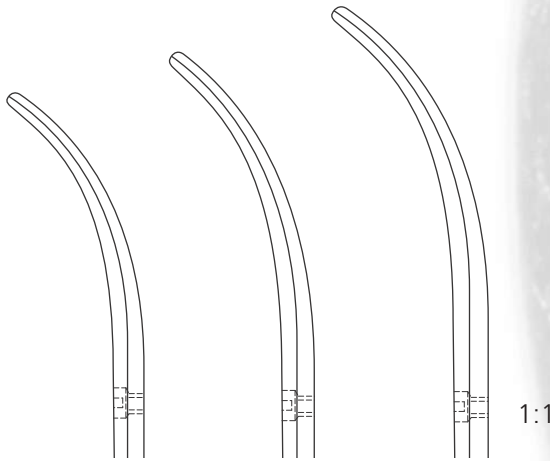

1:1

AD 701-20  
20 cm / 8"

AD 701-23  
23 cm / 9"

AD 701-28  
28 cm / 11"

**Metzenbaum**

stark gebogen  
strong curved  
curva fuerte



1:2

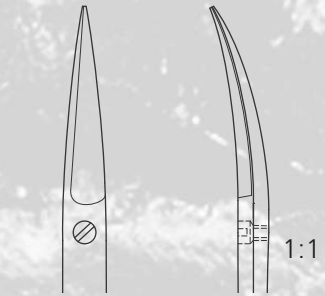

1:1

AD 784-11  
11,5 cm / 4½"

AD 785-11  
11,5 cm / 4½"

**Iris**



1:2

**Standard**

1:1



AE 100-10  
10,5 cm / 4¼"



AE 100-11  
11,5 cm / 4½"



AE 100-13  
13 cm / 5"



AE 100-14  
14,5 cm / 5¾"



AE 100-16  
16 cm / 6¼"

1:1



AE 100-18  
18 cm / 7"



AE 100-20  
20 cm / 8"



AE 100-25  
25 cm / 10"



AE 100-30  
30 cm / 12"

1:1



AE 110-11  
11,5 cm / 4½"



AE 110-13  
13 cm / 5"



AE 110-14  
14,5 cm / 5¾"



AE 110-16  
16 cm / 6¼"

1:1



AE 110-18  
18 cm / 7"



AE 110-20  
20 cm / 8"



AE 110-25  
25 cm / 10"



AE 110-30  
30 cm / 12"



1:2

**Standard**

mittelbreit  
medium wide  
anchura media

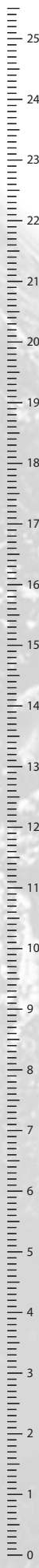

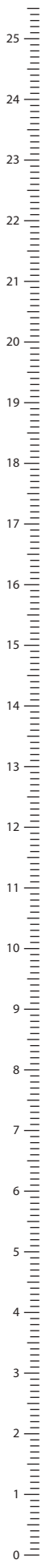

1:2

**Standard**

fein  
fine  
delgado

1:1



AE 120-11  
11,5 cm / 4½"



AE 120-13  
13 cm / 5"



AE 120-14  
14,5 cm / 5¾"



AE 120-16  
16 cm / 6¼"

1:1



AE 120-18  
18 cm / 7"



AE 120-20  
20 cm / 8"

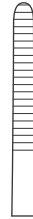

AE 120-25  
25 cm / 10"



AE 120-30  
30 cm / 12"

1:1



AE 160-12  
12 cm / 4¾"



AE 160-15  
15 cm / 6"



1:2

**Adson**



⊕ 1:2 teeth

1:2

**Standard**

1:1



AE 406-10  
10,5 cm / 4"



AE 406-11  
11,5 cm / 4½"



AE 406-13  
13 cm / 5"



AE 406-14  
14,5 cm / 5¾"



AE 406-16  
16 cm / 6¼"

1:1



AE 406-18  
18 cm / 7"



AE 406-20  
20 cm / 8"



AE 406-25  
25 cm / 10"



AE 406-30  
30 cm / 12"



⊕ 1:2 teeth

1:2

**Standard**

mittelbreit  
medium wide  
anchura media

1:1



AE 416-11  
11,5 cm / 4½"



AE 416-13  
13 cm / 5"



AE 416-14  
14,5 cm / 5¾"



AE 416-16  
16 cm / 6¼"

1:1



AE 416-18  
18 cm / 7"



AE 416-20  
20 cm / 8"



AE 416-25  
25 cm / 10"

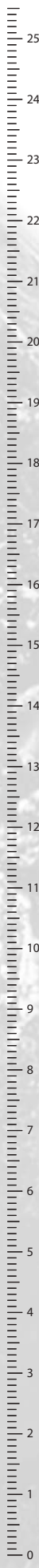

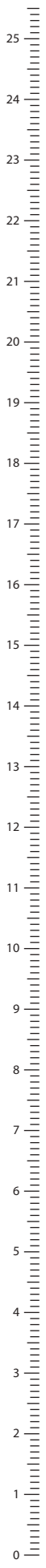

⊕ 1:2 teeth

1:2

**Standard**



AE 426-13  
13 cm / 5"



AE 426-14  
14,5 cm / 5¾"



AE 426-16  
16 cm / 6¼"



AE 426-18  
18 cm / 7"



AE 426-20  
20 cm / 8"

1:1



⊕ 1:2 teeth

1:2

**Adson**



AE 486-12  
12 cm / 4¾"



AE 486-15  
15 cm / 6"

1:1



**Micro-Adson**



**Adson**

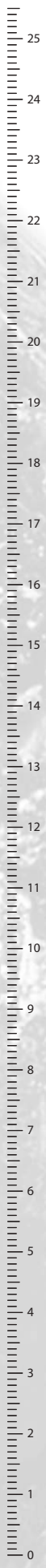

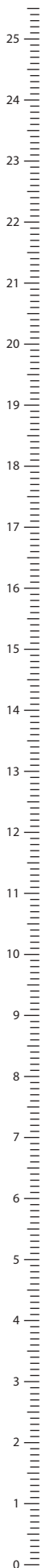

1:2

**DeBakey**



1,5 mm

AF 800-16  
16 cm / 6¼"



AF 800-20  
20 cm / 8"

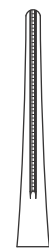

AF 800-24  
24 cm / 9½"



AF 800-30  
30 cm / 12"

1:1



2,0 mm

AF 810-16  
16 cm / 6¼"



AF 810-20  
20 cm / 8"



AF 810-24  
24 cm / 9½"



AF 810-30  
30 cm / 12"

1:1

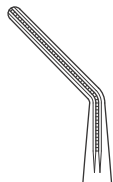

2,0 mm

AF 811-16  
16 cm / 6¼"

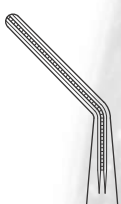

AF 811-20  
20 cm / 8"

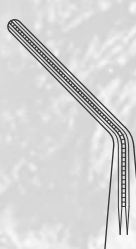

AF 811-24  
24 cm / 9½"



AF 811-30  
30 cm / 12"

1:1



2,7 mm

AF 830-16  
16 cm / 6¼"



AF 830-20  
20 cm / 8"



AF 830-24  
24 cm / 9½"



AF 830-30  
30 cm / 12"

1:1

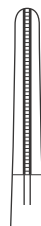

3,5 mm

AF 840-16  
16 cm / 6¼"

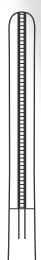

AF 840-20  
20 cm / 8"



AF 840-24  
24 cm / 9½"



AF 840-30  
30 cm / 12"

1:1

**GOLD-GRIP**<sup>®</sup>

Chirurgische und anatomische Pinzetten

Dressing and Tissue Forceps

Pinzas de disección con y sin dientes



1:2



1:1

AH 090-13	13 cm / 5"
AH 090-14	14,5 cm / 5¾"
AH 090-16	16 cm / 6¼"
AH 090-18	18 cm / 7"
AH 090-20	20 cm / 8"
AH 090-25	25 cm / 10"

**Standard**



1:2



1:1

AH 100-15	15 cm / 6"
AH 100-18	18 cm / 7"
AH 100-20	20 cm / 6¼"

**Potts-Smith**



1:2

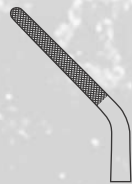

1:1

AH 170-17	AH 171-17
17,5 cm / 7"	17,5 cm / 7"

**Cushing**

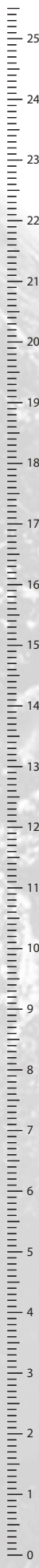



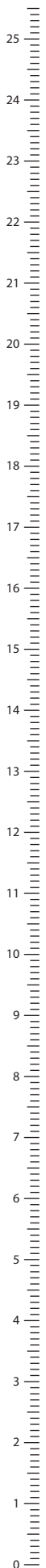

1:2

**Adson**



AH 420-12  
12 cm / 4¾"



AH 420-15  
15 cm / 6"

1:1

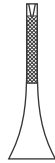

AH 426-12  
12 cm / 4¾"



AH 426-15  
15 cm / 6"

∇ 1:2 teeth

1:1



1:2

**Micro-Adson**



AH 430-12  
12 cm / 4¾"



AH 430-15  
15 cm / 6"

1:1



AH 436-12  
12 cm / 4¾"



AH 436-15  
15 cm / 6"

∇ 1:2 teeth

1:1



1:2

**DeBakey**



1:1

breite - width - anchura 1,5 mm

AH 606-15 15 cm / 6"

AH 606-19 19 cm / 7½"



1:1

breite - width - anchura 2,7 mm

AH 636-15 15 cm / 6"

AH 636-19 19 cm / 7½"

AH 636-24 24 cm / 9½"



1:1

breite - width - anchura 2,0 mm

AH 616-15 15 cm / 6"

AH 616-19 19 cm / 7½"

AH 616-24 24 cm / 9½"



1:1

breite - width - anchura 3,5 mm

AH 646-14 19 cm / 7½"

AH 646-24 24 cm / 9½"



**Micro-Mosquito**

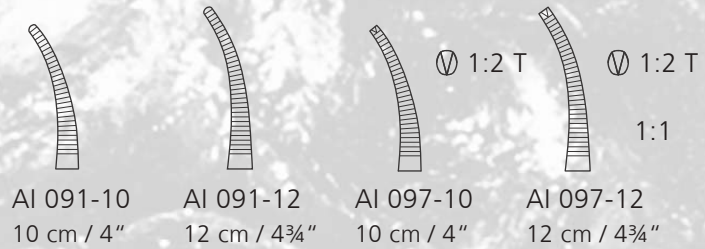
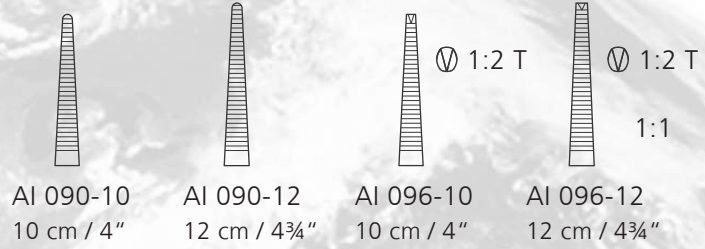

**Halstead-Mosquito**

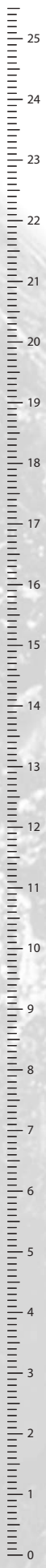
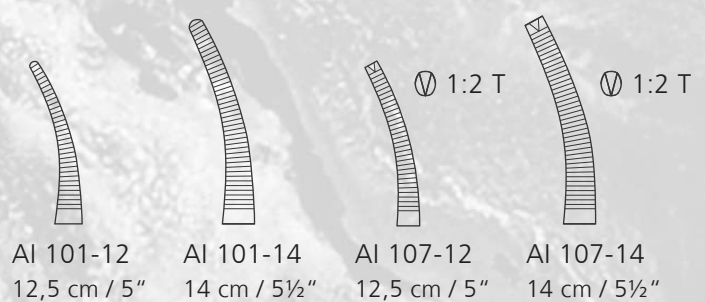
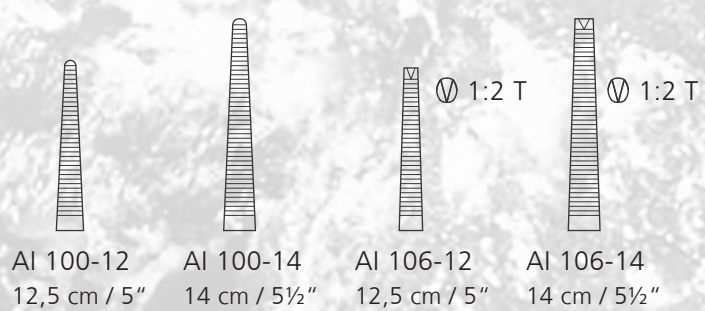

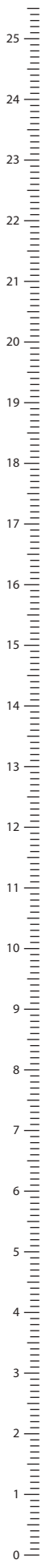

**Halstead**

1:2



AI 111-18  
18 cm / 7"

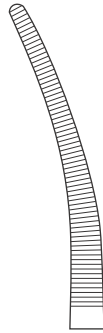

AI 111-21  
21 cm / 8¼"

1:1



**Crile**

1:2



AI 130-14  
14 cm / 5½"



AI 136-14  
14 cm / 5½"

⊕ 1:2 T

1:1



AI 131-14  
14 cm / 5½"



AI 137-14  
14 cm / 5½"

⊕ 1:2 T

1:1



**Rankin-Crile**

1:2



AI 140-16  
16 cm / 6¼"



AI 141-16  
16 cm / 6¼"

1:1



**Heiss**



AI 221-20  
20 cm / 8"



AI 225-20  
20 cm / 8"  
stark gebogen  
strong curved  
curva fuerte



**Crafoord**



AI 241-18  
18 cm / 7"

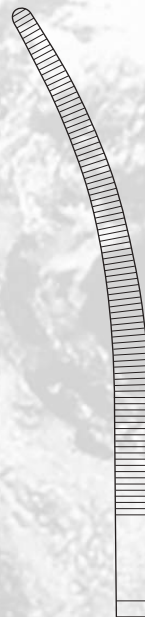

AI 241-24  
24 cm / 9½"

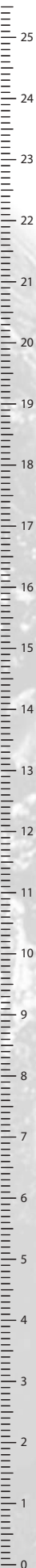

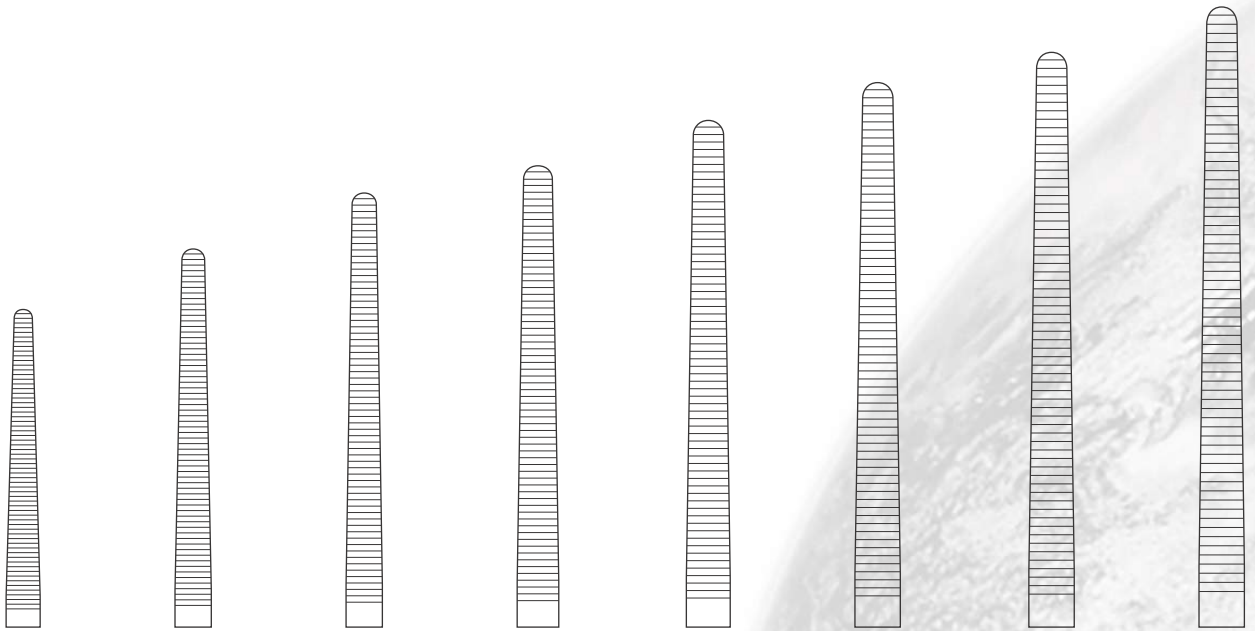
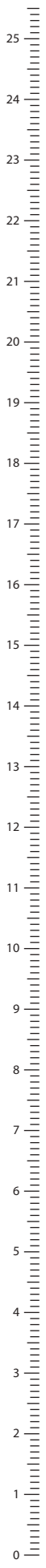

AI 332-14	AI 332-16	AI 332-18	AI 332-20	AI 332-22	AI 332-24	AI 332-26	AI 332-30
14 cm / 5½"	16 cm / 6¼"	18 cm / 7"	20 cm / 8"	22 cm / 8¾"	24 cm / 9½"	26 cm / 10¼"	30 cm / 12"

1:1



1:2

**Pean (Rochester)**

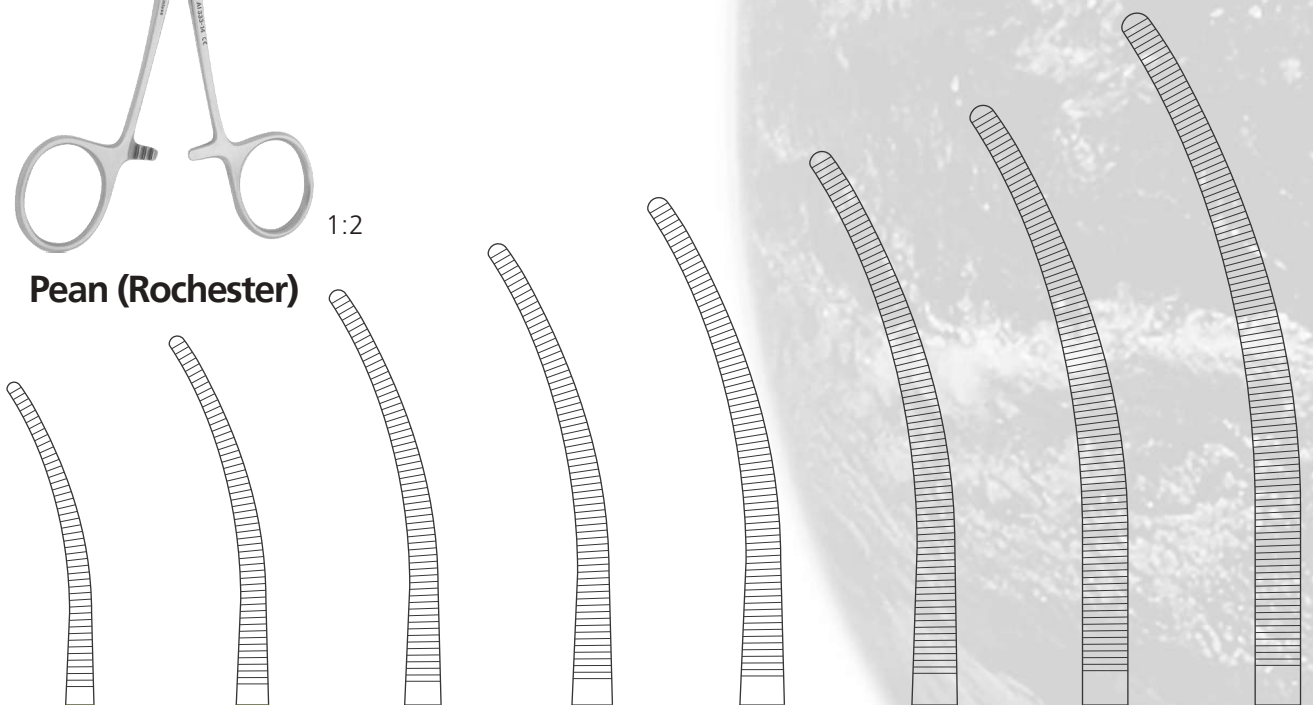

AI 333-14	AI 333-16	AI 333-18	AI 333-20	AI 333-22	AI 333-24	AI 333-26	AI 333-30
14 cm / 5½"	16 cm / 6¼"	18 cm / 7"	20 cm / 8"	22 cm / 8¾"	24 cm / 9½"	26 cm / 10¼"	30 cm / 12"

1:1

1:1



AI 416-14  
14 cm / 5½"



AI 416-16  
16 cm / 6¼"



AI 416-18  
18 cm / 7"



AI 416-20  
20 cm / 8"



AI 416-22  
22 cm / 8¾"



AI 416-24  
24 cm / 9½"



AI 416-26  
26 cm / 10¼"



AI 416-30  
30 cm / 12"



**Kocher (Rochester-Ochsner)**

⊕ 1:2 T

1:2

1:1



AI 417-14  
14 cm / 5½"



AI 417-16  
16 cm / 6¼"



AI 417-18  
18 cm / 7"



AI 417-20  
20 cm / 8"



AI 417-22  
22 cm / 8¾"



AI 417-24  
24 cm / 9½"

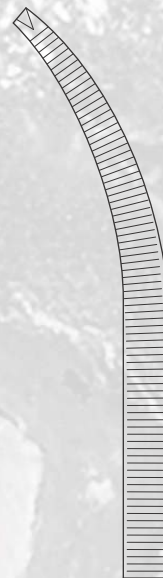

AI 417-26  
26 cm / 10¼"

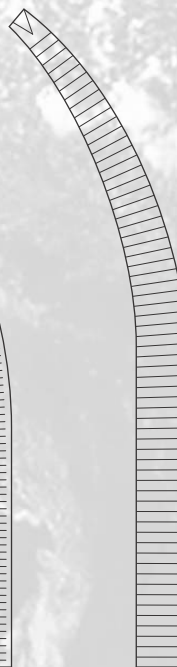

AI 417-30  
30 cm / 12"

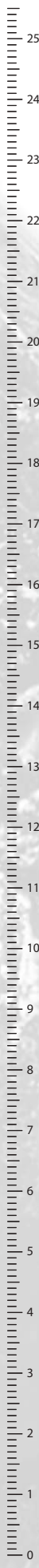



1:2



AI 451-14  
14 cm / 5½"

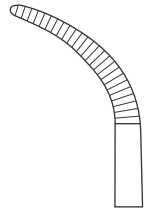

AI 451-18  
18 cm / 7"

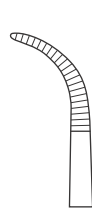

AI 453-14  
14 cm / 5½"

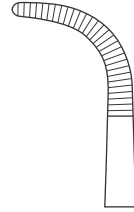

AI 453-18  
18 cm / 7"

1:1

**Baby-Mixer (Baby-Adson)**



1:2

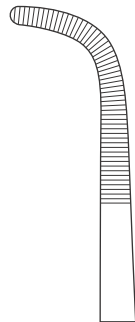

AI 465-20  
20 cm / 8"

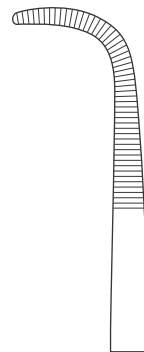

AI 465-24  
24 cm / 9½"



AI 465-28  
28 cm / 11"

1:1

**Kantrowitz**



**Gemini**

1:2



AI 535-14  
14 cm / 5½"



AI 535-16  
16 cm / 6¼"

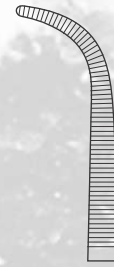

AI 535-18  
18 cm / 7"

1:1



AI 535-20  
20 cm / 8"

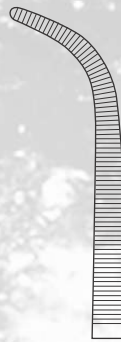

AI 535-23  
23 cm / 9"



AI 535-25  
25 cm / 10"



AI 535-28  
28 cm / 11"

1:1

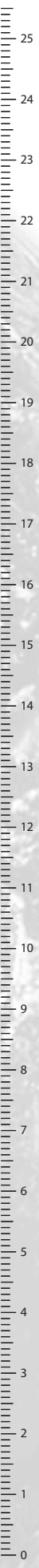





**Overholt-Geissendörfer**

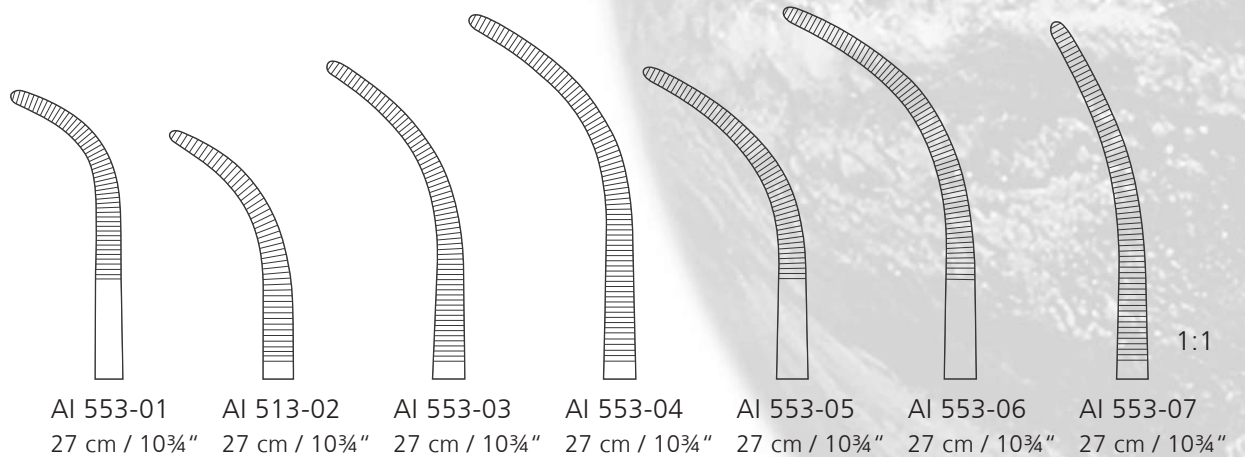
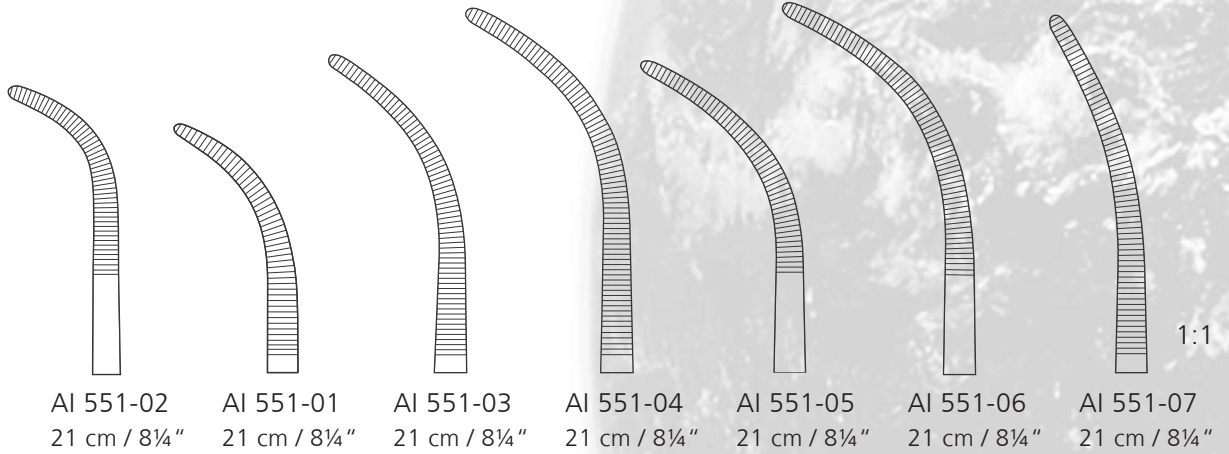



**Backhaus**

1:2



AK 151-08  
8 cm / 3¼"



AK 151-11  
11 cm / 4½"



AK 151-13  
13 cm / 5"



AK 151-15  
15 cm / 6"

1:1

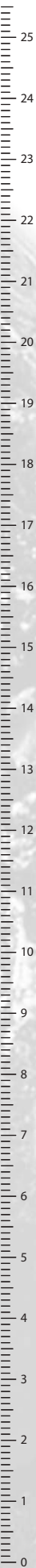

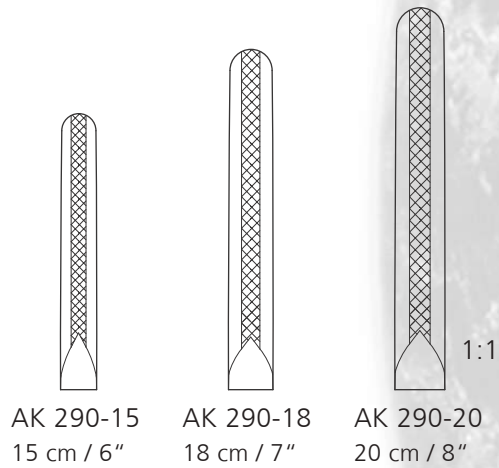
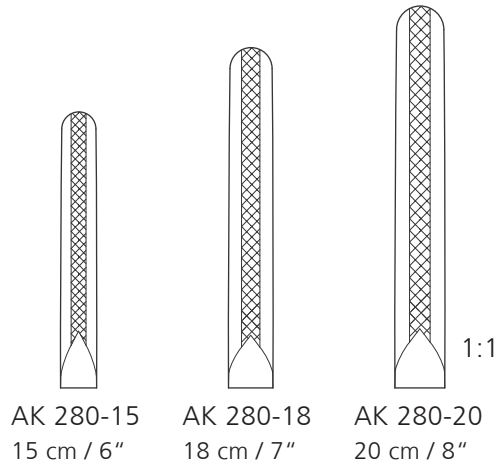



**Crile-Wood**

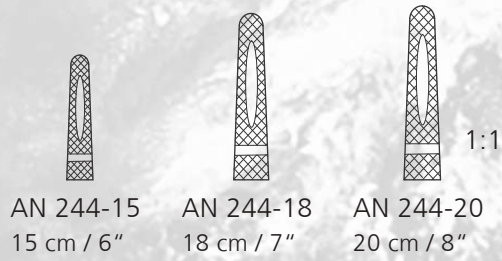

**Mayo-Hegar**

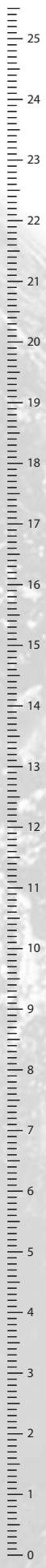
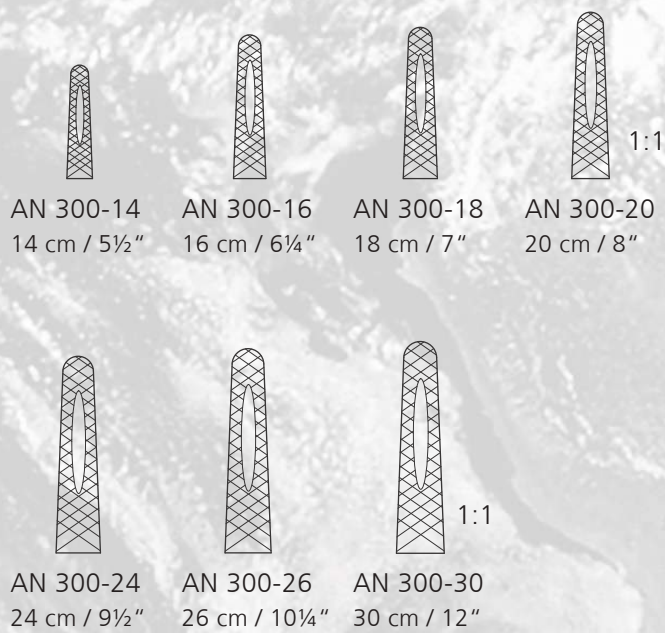



1:2

**Neivert**



1:1

AR 110-13  
13 cm / 5"  
ein Ring abgewinkelt  
one ring angled  
un dorado angulado



1:2

**Halsey**



AR 120-13  
13 cm / 5"



1:1

AR 124-13  
13 cm / 5"



1:2

**Hegar-Baumgartner**



AR 150-13  
13 cm / 5"



1:1

AR 150-14  
14 cm / 5½"



1:2

**Webster**



1:1

AR 170-13  
13 cm / 5"



**Derf**

1:2  
AR 190-12  
12 cm / 4¾"



**Mayo-Hegar**

1:2

AR 200-16  
16 cm / 6¼"

AR 200-18  
18 cm / 7"

1:1

AR 200-20  
20 cm / 8"

AR 200-24  
24 cm / 9½"

1:1

AR 200-26  
26 cm / 10¼"

AR 200-30  
30 cm / 12"

1:1



**Mayo-Hegar**  
kräftiges Modell  
heavy pattern  
modelo fuerte

AR 205-20  
20 cm / 8"

AR 205-24  
24 cm / 9½"

1:1

1:2



**Crile-Wood**

1:2

AR 220-15  
15 cm / 6"

AR 220-18  
18 cm / 7"

1:1

AR 220-20  
20 cm / 8"

AR 220-23  
23 cm / 9"

1:1

AR 220-26  
26 cm / 10¼"

AR 220-30  
30 cm / 12"

1:1

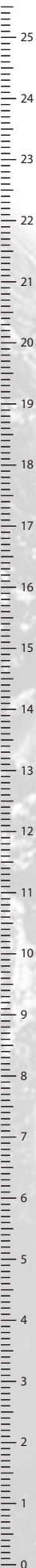

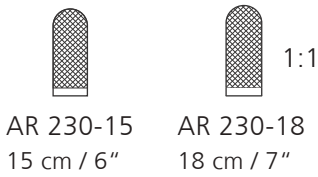
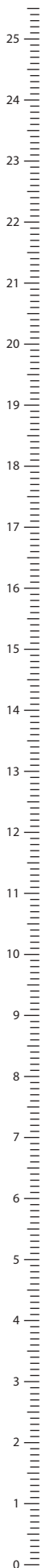

AR 230-15  
15 cm / 6"

1:2

AR 230-18  
18 cm / 7"

1:1

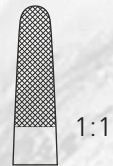

AR 240-18  
18,5 cm / 7 1/4"

1:2

**Baumgartner**  
Sternumnadelhalter  
Sternum Needle Holder  
Porta-aguja para esternón

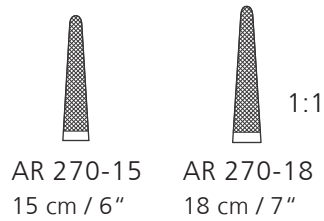

AR 270-15  
15 cm / 6"

AR 270-18  
18 cm / 7"

1:1

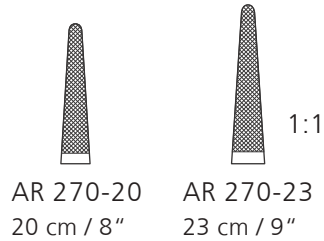

AR 270-20  
20 cm / 8"

AR 270-23  
23 cm / 9"

1:1

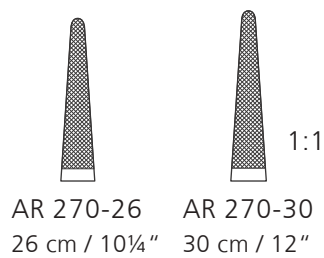

AR 270-26  
26 cm / 10 1/4"

AR 270-30  
30 cm / 12"

1:1

**DeBakey**

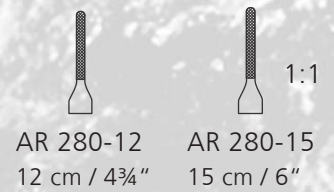

AR 280-12  
12 cm / 4 3/4"

AR 280-15  
15 cm / 6"

1:1



AR 280-18  
18 cm / 7"

AR 280-20  
20 cm / 8"

1:1







AR 280-23  
23 cm / 9"

1:1

**Mini Ryder**  
Breite  
width  
anchura 1,1 mm



**Hegar-Vascular**

				1:1
AR 290-14 14 cm / 5½"	AR 290-18 18 cm / 7"	AR 290-20 20 cm / 8"	AR 290-23 23 cm / 9"	

1:2

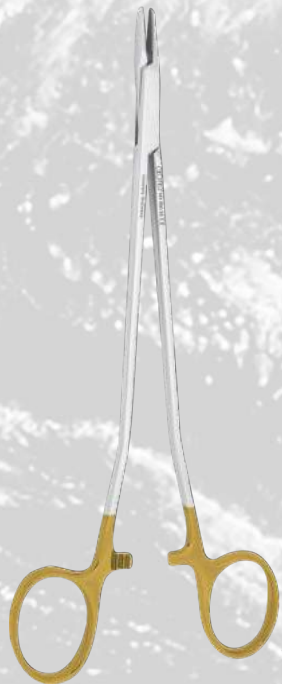

**Sarot**

			1:1
AR 390-18 18 cm / 7"	AR 390-20 20 cm / 8"	AR 390-26 26 cm / 10¼"	

1:2

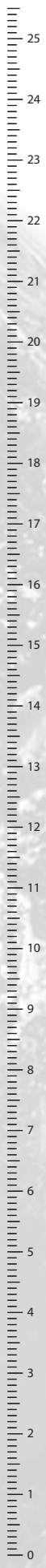





1:2

**Weitlaner**  
2 : 3 Teeth

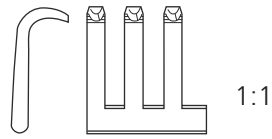

1:1

AZ 100-10  
10,5 cm / 4¼"

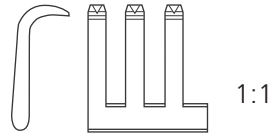

1:1

AZ 104-10  
10,5 cm / 4¼"



1:2

**Wullstein-Weitlaner**  
3 : 3 Teeth

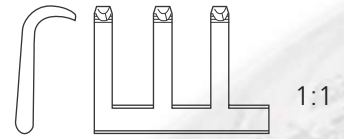

1:1

AZ 110-13  
13 cm / 5"

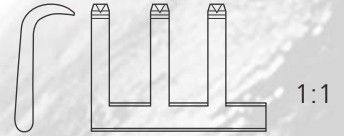

1:1

AZ 114-13  
13 cm / 5"



1:2

**Weitlaner**  
3 : 4 Teeth

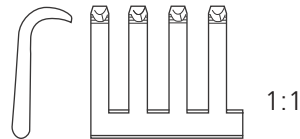

1:1

AZ 120-13  
13 cm / 5"

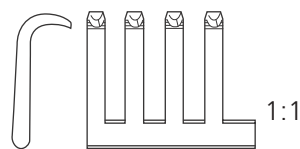

1:1

AZ 120-16  
16,5 cm / 6½"

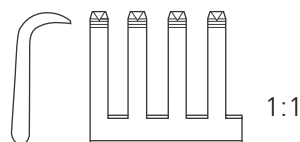

1:1

AZ 124-13  
13 cm / 5"

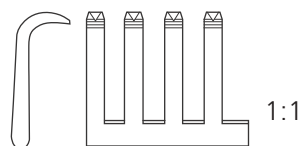

1:1

AZ 124-16  
16,5 cm / 6½"



1:2

**Weitlaner**  
3 : 4 Teeth

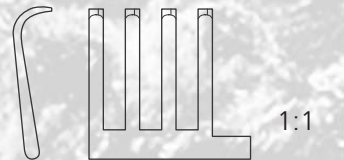

1:1

AZ 170-20    AZ 170-26  
20 cm / 8"    26 cm / 10¼"

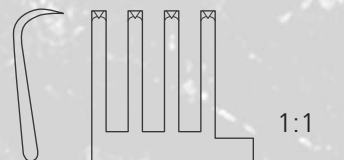

1:1

AZ 174-20    AZ 174-26  
20 cm / 8"    26 cm / 10¼"



1:2

**Adson**  
3 : 4 Teeth

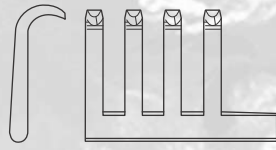

1:1

AZ 200-13  
13 cm / 5"

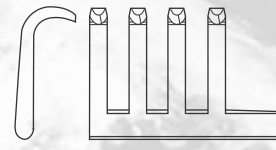

1:1

AZ 200-16  
16 cm / 6¼"

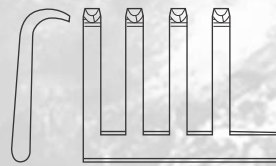

1:1

AZ 200-20  
20 cm / 8"

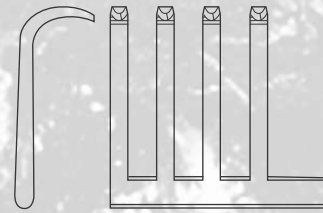

1:1

AZ 200-26  
26 cm / 10¼"

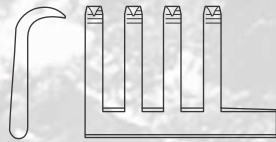

1:1

AZ 204-13  
13 cm / 5"

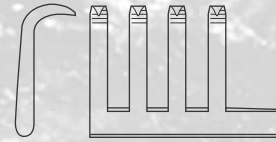

1:1

AZ 204-16  
16 cm / 6¼"

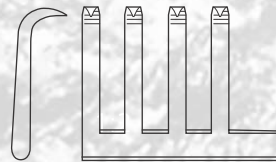

1:1

AZ 204-20  
20 cm / 8"

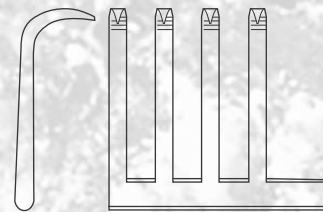

1:1

AZ 204-26  
26 cm / 10¼"

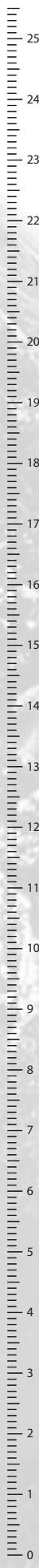



Maße der Blätter: Tiefe x Breite  
Dimensions of blades: Depth x Width  
Dimensiones de las hojas: Profundidad x Anchura

### Henley

komplett 3 x 4 Zähne, stumpf  
complete 3 x 4 teeth, blunt  
completo 3 x 4 dientes, romos  
16,5 cm / 6½"  
AZ 370-00



bestehend aus - including - compuesto de:

Sperrer allein - frame only - cuadro solo  
AZ 371-01

Mittelvalve - center blade - valva central  
AZ 372-19 16 mm x 19 mm

Mittelvalve - center blade - valva central  
AZ 372-25 16 mm x 25 mm

Mittelvalve - center blade - valva central  
AZ 372-32 16 mm x 32 mm

komplett 3 x 4 Zähne, scharf  
complete 3 x 4 teeth, sharp  
completo 3 x 4 dientes, agudos  
16,5 cm / 6½"  
AZ 374-00

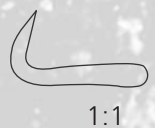

bestehend aus - including - compuesto de:

Sperrer allein - frame only - cuadro solo  
AZ 374-01

Mittelvalve - center blade - valva central  
AZ 372-19 16 mm x 19 mm

Mittelvalve - center blade - valva central  
AZ 372-25 16 mm x 25 mm

Mittelvalve - center blade - valva central  
AZ 372-32 16 mm x 32 mm



Maße der Blätter: Tiefe x Breite  
Dimensions of blades: Depth x Width  
Dimensiones de las hojas: Profundidad x Anchura

### **Baby-Balfour**

komplett - complete - completo  
AZ 450-00

bestehend aus - including - compuesto de:

Sperrer mit Seitenvalven 27 mm x 27 mm  
frame with lateral blades 27 mm x 27 mm  
cuadro con valvas laterales 27 mm x 27 mm

Spreizweite - spread - abertura 90 mm / 3½"  
AZ 451-01

Mittelvalve - center blade - valva central  
AZ 452-24 24 mm x 20 mm

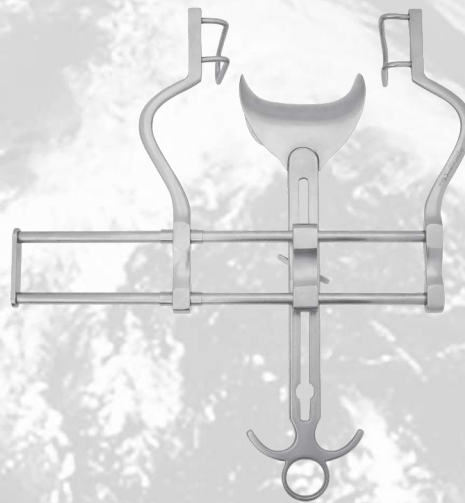

### **Balfour**

komplett - complete - completo  
AZ 460-00

bestehend aus - including - compuesto de:

Sperrer mit Seitenvalven 63 mm x 35 mm  
frame with lateral blades 63 mm x 35 mm  
cuadro con valvas laterales 63 mm x 35 mm

Spreizweite - spread - abertura 180 mm / 7"  
AZ 461-01

Mittelvalve - center blade - valva central  
AZ 462-45 45 mm x 80 mm

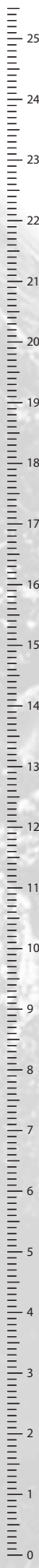

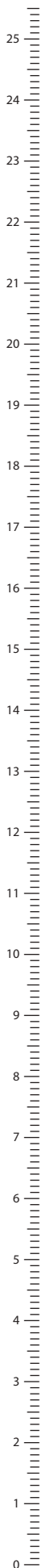

**Allis**  
5 : 6 Teeth

1:2



1:1  
MC 120-15  
15 cm / 6"



1:1  
MC 120-19  
19 cm / 7½"



1:1  
MC 120-25  
25 cm / 10"



**Allis**  
atraumatisch  
atraumatic  
atraumatica

1:2



1:1  
MC 190-16  
16 cm / 6¼"



1:1  
MC 190-20  
20 cm / 8"



1:1  
MC 190-25  
25 cm / 10"



**Babcock**  
atraumatisch  
atraumatic  
atraumatica

1:2



1:1  
MC 350-16  
16 cm / 6¼"

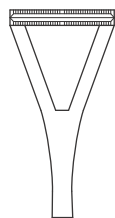

1:1  
MC 350-20  
20 cm / 8"



**Babcock GOLD GRIP**<sup>®</sup>

1:2



1:1  
MC 400-16 16 cm / 6¼"

MC 400-20 20 cm / 8"



1:2

**Collin-Duval**



1:1

MC 410-18  
18 cm / 7"

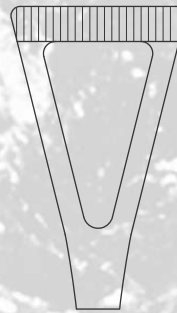

1:1

MC 412-20  
20 cm / 8"

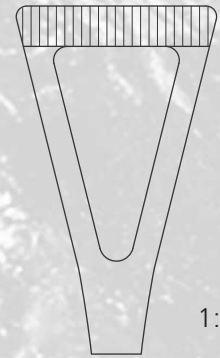

1:1

MC 412-23  
23 cm / 9"



1:2

**Collin-Duval GOLD-GRIP**<sup>®</sup>



1:1

MC 420-20  
20 cm / 8"

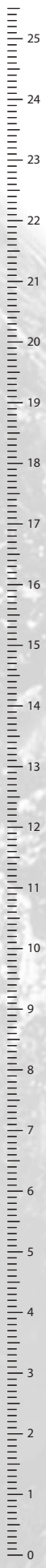



# GEOMED<sup>®</sup>

MEDIZIN - TECHNIK

**GEOMED<sup>®</sup>**  
**MEDIZIN-TECHNIK GMBH & CO. KG**

Ludwigstaler Straße 27  
D-78532 Tuttlingen

Postfach 40 47  
D-78505 Tuttlingen

Germany

Telefon ++49 (0) 74 61 / 93 55 - 0  
Telefax ++49 (0) 74 61 / 93 55 - 93

e-Mail: [info@geomed.de](mailto:info@geomed.de)  
Internet: [www.geomed.de](http://www.geomed.de)

